

# Table of Contents

<b>Building your MINI+</b> .....	3
Step 1 - Preassembled vs kit version .....	4
Step 2 - Different hardware revisions .....	4
Step 3 - Two version of the Spool holder assembly .....	5
Step 4 - All the required tools are included .....	6
Step 5 - Use labels for reference .....	6
Step 6 - We are here for you! .....	7
Step 7 - XYZ-axes parts preparation .....	7
Step 8 - XYZ-axes parts preparation .....	8
Step 9 - Foam pads - preparation .....	8
Step 10 - Foam pads installation .....	9
Step 11 - Opening the box with the electronics .....	9
Step 12 - Connecting the LCD cable .....	10
Step 13 - Connecting the Y and XZ-axis assembly .....	11
Step 14 - Joining the parts together - preparation .....	12
Step 15 - Protecting the LCD cable .....	12
Step 16 - Joining the parts together - phase 1 .....	13
Step 17 - Joining the parts together - phase 2 .....	13
Step 18 - Joining the parts together - phase 3 .....	14
Step 19 - Aligning the XZ-axis assembly .....	14
Step 20 - Final tightening .....	15
Step 21 - Haribo time! .....	15
Step 22 - LCD parts preparation .....	16
Step 23 - Mounting the LCD .....	16
Step 24 - Connecting the LCD .....	17
Step 25 - Guiding the LCD cable .....	17
Step 26 - Connecting the Y-axis motor .....	17
Step 27 - Connecting the heatbed cable .....	18
Step 28 - Filament sensor (optional) .....	18
Step 29 - Filament sensor installation (optional) .....	19
Step 30 - Connecting the filament sensor (optional) .....	19
Step 31 - Covering the electronics .....	20
Step 32 - Haribo time! .....	20
Step 33 - Spool holder parts preparation .....	21
Step 34 - Base assembly (part 1) .....	21
Step 35 - Base assembly (part 2) .....	22
Step 36 - Foam pads installation (part 1) .....	22
Step 37 - Foam pads installation (part 2) .....	23
Step 38 - Adjusting the spool holder width .....	23
Step 39 - Haribo time! .....	24
Step 40 - Finalising the assembly .....	24
Step 41 - Connecting the PSU .....	25
Step 42 - What is next? .....	25
<b>Building your MINI+ (printed spool holder)</b> .....	26
Step 1 - Preassembled vs kit version .....	27
Step 2 - Different hardware revisions .....	27
Step 3 - All the required tools are included .....	28
Step 4 - Use labels for reference .....	28
Step 5 - We are here for you! .....	29
Step 6 - XYZ-axes parts preparation .....	29

Step 7 - XYZ-axes parts preparation .....	30
Step 8 - Foam pads - preparation .....	30
Step 9 - Foam pads installation .....	31
Step 10 - Opening the box with the electronics .....	31
Step 11 - Connecting the LCD cable .....	32
Step 12 - Connecting the Y and XZ-axis assembly .....	33
Step 13 - Joining the parts together - preparation .....	34
Step 14 - Protecting the LCD cable .....	34
Step 15 - Joining the parts together - phase 1 .....	35
Step 16 - Joining the parts together - phase 2 .....	35
Step 17 - Joining the parts together - phase 3 .....	36
Step 18 - Aligning the XZ-axis assembly .....	36
Step 19 - Final tightening .....	37
Step 20 - Haribo time! .....	37
Step 21 - LCD parts preparation .....	38
Step 22 - Mounting the LCD .....	38
Step 23 - Connecting the LCD .....	39
Step 24 - Guiding the LCD cable .....	39
Step 25 - Connecting the Y-axis motor .....	39
Step 26 - Connecting the heatbed cable .....	40
Step 27 - Filament sensor (optional) .....	40
Step 28 - Filament sensor installation (optional) .....	41
Step 29 - Connecting the filament sensor (optional) .....	41
Step 30 - Covering the electronics .....	42
Step 31 - Haribo time! .....	42
Step 32 - Spool holder parts preparation .....	43
Step 33 - Spool holder parts preparation .....	43
Step 34 - Assembling the spool holder base(s) .....	44
Step 35 - Adding the spool holder rails .....	44
Step 36 - Adjusting the spool holder width .....	45
Step 37 - Attaching anti-slip pads .....	45
Step 38 - Haribo time! .....	46
Step 39 - Finalising the assembly .....	46
Step 40 - Connecting the PSU .....	47
Step 41 - What is next? .....	47
<b>Manual changelog MINI+ semi-assembly .....</b>	<b>48</b>
Step 1 - Version history .....	49
Step 2 - Changes to the manual (1) .....	49
Step 3 - Changes to the manual (2) .....	50
Step 4 - Changes to the manual (3) .....	50
Step 5 - Changes to the manual (4) .....	51
Step 6 - Changes to the manual (5) .....	51
Step 7 - Changes to the manual (6) .....	52
Step 8 - Changes to the manual (7) .....	52

# Building your MINI+

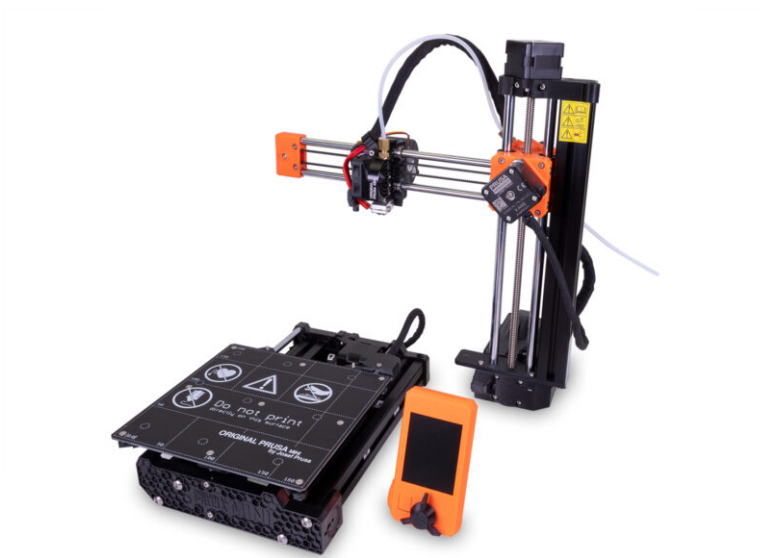

## STEP 1 Preassembled vs kit version

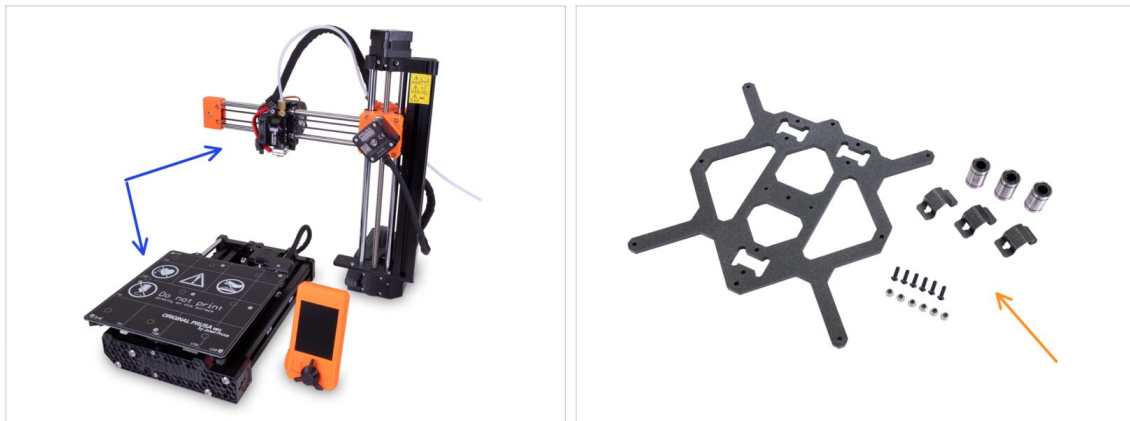

**⚠ Important!** There are **two versions** of the Original Prusa MINI+. Before you continue, select yours:

- **Semi-assembled version:** the printer is almost assembled and requires you to connect the major parts together. You can continue using these assembly instructions.
- **Kit version:** you have to assemble the printer using individual parts from the ground up. Please continue using the online version available at [help.prusa3d.com/MINI-kit](http://help.prusa3d.com/MINI-kit) or you can use the PDF version included on the silver USB drive.

## STEP 2 Different hardware revisions



- There are more hardware revisions of the XZ-axis, please check the following photos to select the appropriate assembly procedure:
  - **The XZ-axis has the opening on the right**, continue using this assembly guide.
  - **The XZ-axis has the opening on the left**, jump to the following guide [Building your MINI and early MINI+](#)

## STEP 3 Two version of the Spool holder assembly

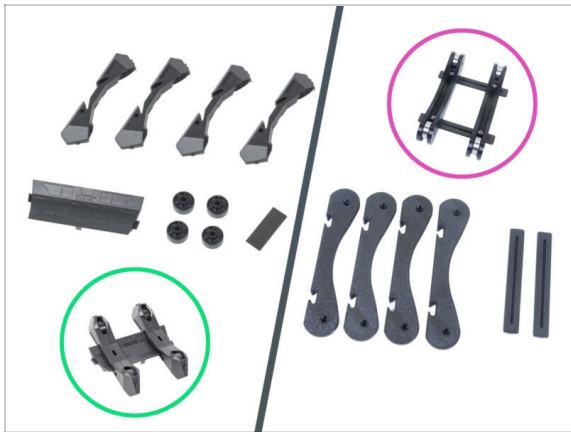

- ⚠ The Original Prusa MINI+ comes with two versions of spool holders. Each version has a different assembly procedure.**
- ◆ Take a closer look at the items from the SPOOL HOLDER package and choose the appropriate instructions:**
- ◆ NEW version** - spool holder parts are injection molded including wheels. Follow the instructions in this manual.
  - ◆ OLD version** - spool holder parts are printed except wheels (bearings). Follow the instructions in the guide [Building your MINI+ \(printed spool holder\)](#)

## STEP 4 All the required tools are included

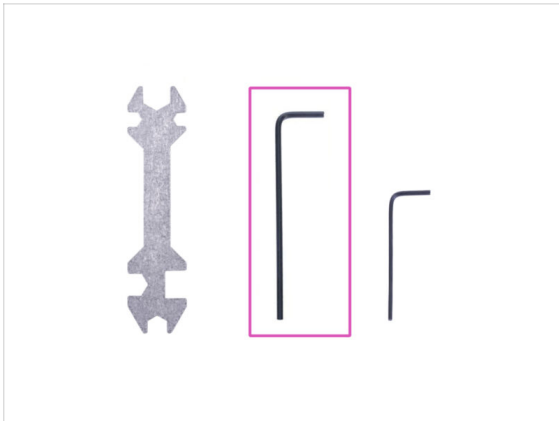

● For this manual, please prepare:

● 2.5mm Allen key (1x)

● Mini bag of Haribo bears (1x)

ⓘ Only the 2.5mm Allen key is required for the assembly. Other tools will be used for maintenance of the printer, see the enclosed handbook part for more information.

ⓘ No soldering or wire crimping is required.

⚠ **Keep the bag with the Haribo bears closed for now and hide it!** Unattended bags tend to mysteriously disappear.

## STEP 5 Use labels for reference

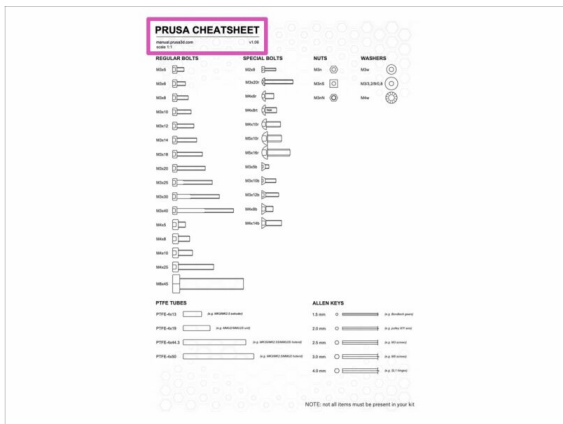
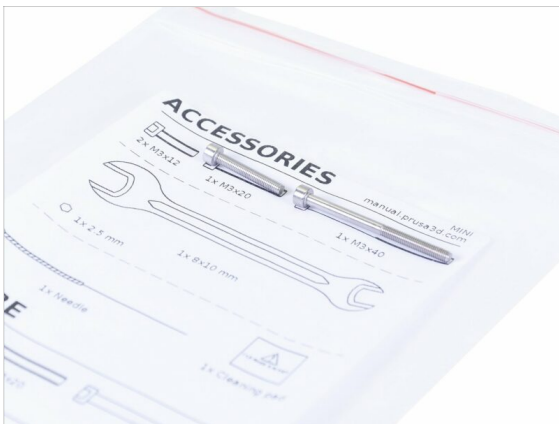

ⓘ Most of the labels are scaled 1:1 and can be used to identify the part :-)

● For identification of the most common screws, nuts and PTFE tubes, you can also use the enclosed letter, which contains the Prusa Cheatsheet on the other side.

ⓘ You can download the Prusa Cheatsheet from our site [prusa3d.com/cheatsheet](https://prusa3d.com/cheatsheet). Print it at 100 %, don't rescale it, otherwise, it won't work.

## STEP 6 We are here for you!

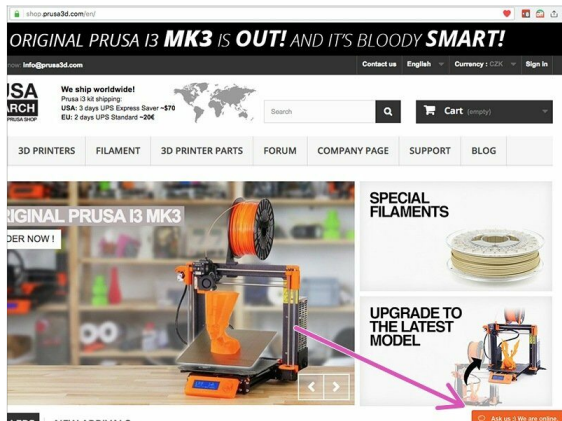
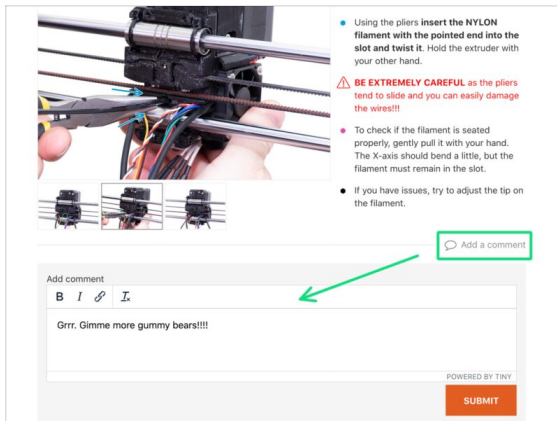

- Lost in the instructions, missing a screw or dealing with a damaged printed part? **Let us know!**
- You can contact us using the following channels:
  - In the online version, use comments under each step.
  - Use our 24/7 live chat at [shop.prusa3d.com](https://shop.prusa3d.com)
  - Write an email to [info@prusa3d.com](mailto:info@prusa3d.com)

## STEP 7 XYZ-axes parts preparation



- For the following steps, please prepare:
  - XZ-axis assembly
  - M3x40 screw (1x)
  - M3x20 screw (1x)
  - M3x12 screw (1x)
- Note the second M3x20 screw in the package, will be used later on.
- The list continues in the next step...

## STEP 8 XYZ-axes parts preparation



● For the following steps, please prepare:

- Y-axis assembly
- Foam block or foam pads set (1x)

## STEP 9 Foam pads - preparation

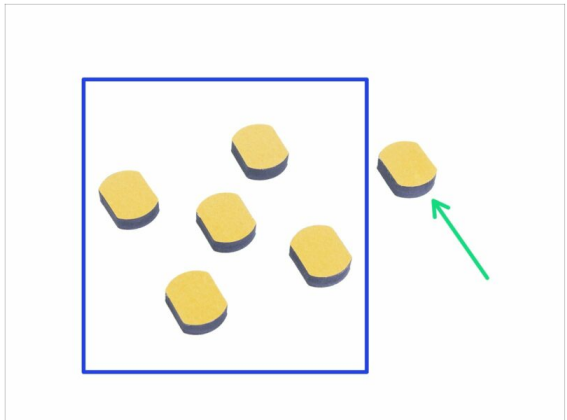
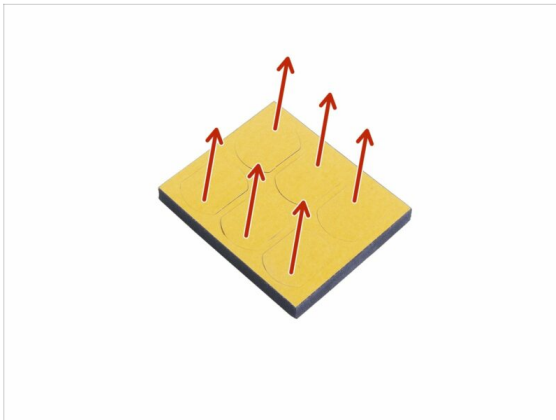

- Gently push all the pads out of the block.
- You will need five foam pads for the following steps.
- Keep the remaining sixth pad as a spare.



## STEP 10 Foam pads installation



- ◆ Peel the protective film from all pads. Be careful, there is glue (adhesive) applied on the pad.
  - ◆ Lay the XZ-axis carefully on its side and then glue the first foam pad into the groove on the bottom side of the electronics box.
  - ◆ Rotate the Y-axis so that the heatbed is facing down. Put a soft pad or cloth underneath it to prevent scratches.
  - ◆ Glue four foam pads onto the ends of the frame's **aluminum extrusions**, like in the picture. Mind the correct orientation.
- ⚠ **Do not glue any of these four pads on the plastic front and rear plate!**

## STEP 11 Opening the box with the electronics



- ⚠ **Make sure that the Z-axis is in the upper position. If not, using your fingers turn the leadscrew and move the Z-axis up.**
  - ◆ Release and remove the M3 screw on the box with the electronics.
  - ◆ Remove the printed cable cover.
  - ◆ Lift the electronics cover slightly. Before you remove it completely, pull it first towards the vertical aluminium extrusion to release both pins from the slots (holes on older design).
- ⓘ Keep the box opened, we need to connect multiple cables throughout this manual.

## STEP 12 Connecting the LCD cable

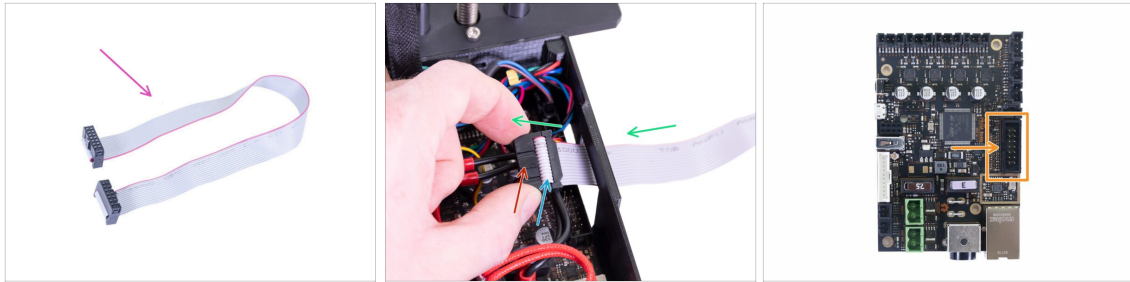

- ◆ **For this step please prepare the LCD cable (flat grey).**
- ◆ Take the LCD cable and push it through the hole in the box with the electronics.
- ◆ Make sure the "tooth" on the connector is facing up.
- ◆ Make sure the cable fold in the connector is facing up.
- ◆ Connect the LCD connector to the board. Mind the orientation of the connector, there is a notch on one side (see the arrow).

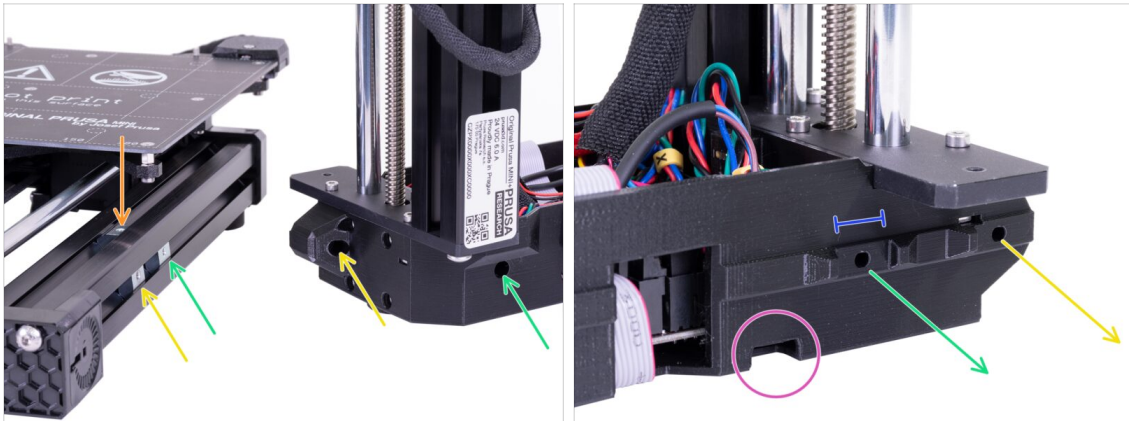
**STEP 13** Connecting the Y and XZ-axis assembly

**⚠ IMPORTANT:** Read the following lines carefully. You need to align all three silver M3nE nuts in the Y-axis assembly with the correct counterpart holes in the XZ-axis assembly!

- There are a total of **three M3nE** nuts in the extrusion:
  - **The first** (the longest) on the right will be used to connect both parts together using the M3x40 screw.
  - **The second** (the second longest) will be also used to join parts, but using the M3x20 screw.
  - **The third** is located in the top part of the extrusion (not visible in the picture). The instructions on this one will be provided later on.

**⚠ Do not insert any of these screws at this time. Wait for the instructions in the following steps.**

- The second photo shows the inner side of the XZ assembly, which will be in the direct contact with aluminium extrusion and the silver M3nE nuts. Make sure the first nut fits inside the "clamp".
- Take a look at the small hole on the bottom edge. We will use this hole in the following steps to guide the cable from the Y-axis motor.

## STEP 14 Joining the parts together - preparation



- 🟠 Locate the Y-axis motor cable placed in the extrusion and pull it out carefully.
- 🟢 Take the rubber band off from the cable, guide the cable below the extrusion and out (see the picture).
- 📄 **i** The cable on the latest units is shipped without the rubber band. However, the procedure is the same.
- 🟡 Move the heatbed all the way to the right.
- 🟡 Place the right M3nE nut approximately in the middle of the extrusion's length, but make sure it is not under the heatbed structure.

## STEP 15 Protecting the LCD cable

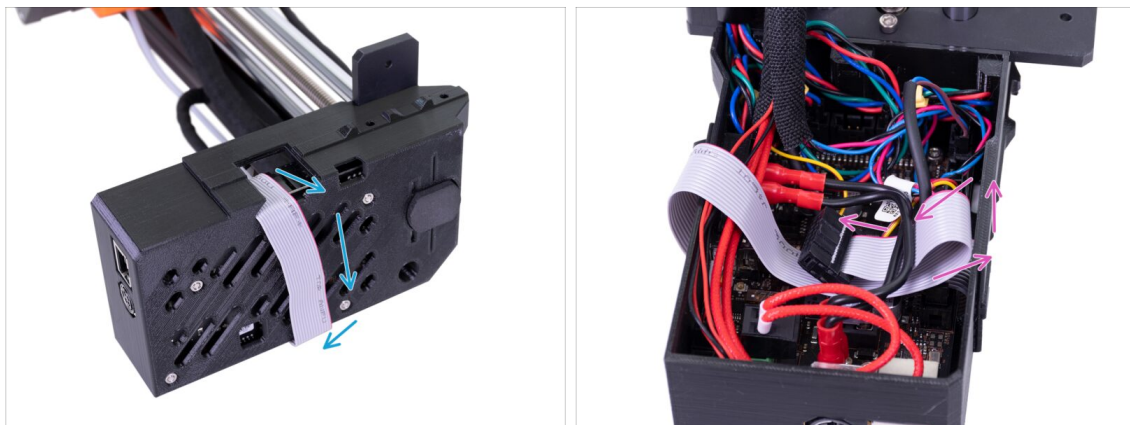

- ⚠️ **WARNING:** From now on proceed carefully while moving the XZ-axis. The LCD cable is facing down and might get damaged.
- ⬛ In order to protect the cable, please follow the instructions below. Also, don't try any other orientation, because it will complicate the assembly.
- 🟡 Carefully lay the XZ-axis on its side (see the picture) and start wrapping the LCD cable around the box. Don't stretch the cable.
- 🟡 Now, tilt the axis back to get better access inside the electronics box and gently insert the cable in. Make a loop under the power button cables. Note, that this is only a temporary solution.

## STEP 16 Joining the parts together - phase 1

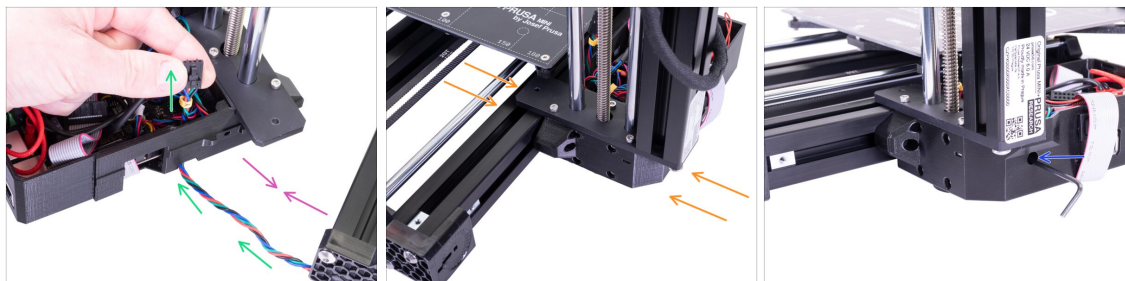

- ◆ Move the XZ-axis closer to the Y-axis so that the Y-axis motor cable reaches the electronics.
- ◆ Guide the Y-axis motor cable through the hole in the electronics box. Do not connect the cable to the electronics yet, we'll connect it later.
- ◆ Push both parts together and try fitting the "clamp" (XZ assembly) directly on the M3nE nut, which you have moved to the centre of the extrusion.
- ⚠ **WARNING: Be careful not to pinch the Y-axis motor cable between both parts!**
- ◆ Use the M3x40 screw to connect both parts. In case you can't reach the thread of the nut, wiggle with the screw a bit inside the plastic base of the printer. **DON'T tighten the screw fully yet!**

## STEP 17 Joining the parts together - phase 2

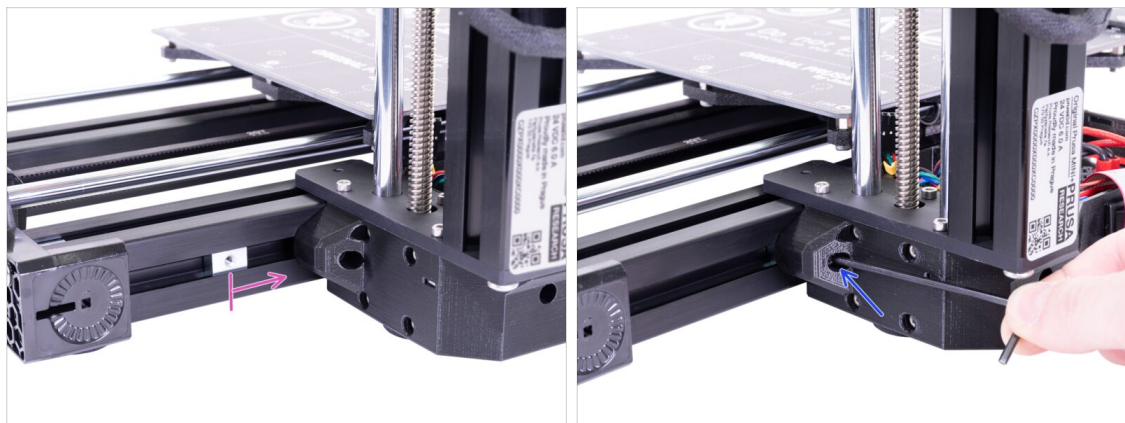

- ◆ Take the second M3nE nut from the left and move it all the way to the right, use the Allen key and gently push it in. There is a notch inside, which will align it properly for the second screw.
- ◆ Use the M3x20 screw and again tighten it just slightly, but ensure you have reached the nut. **DON'T tighten the screw fully yet!**

## STEP 18 Joining the parts together - phase 3

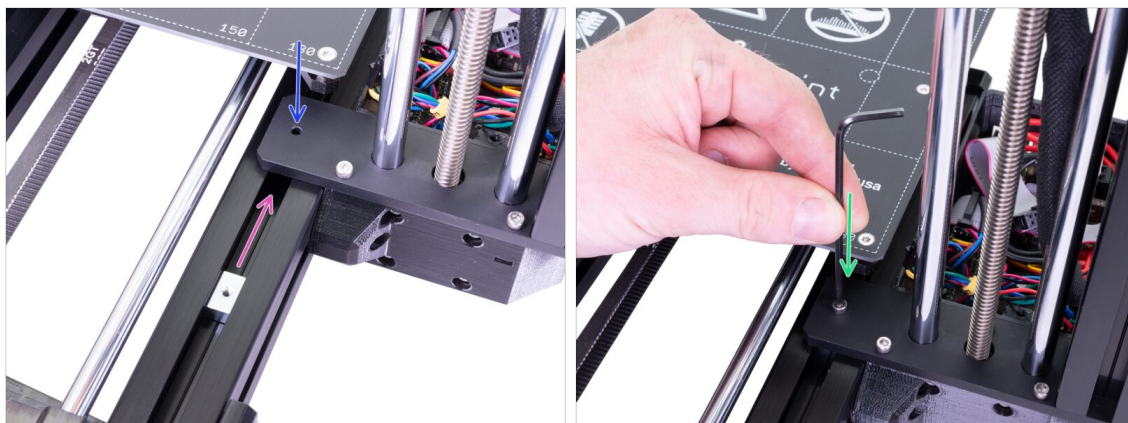

- ◆ Now, take the M3nE nut in the upper part of the extrusion and slide it under the steel plate.
- ◆ Make sure the hole in the nut matches the hole in the plate. Use the Allen key to align it.
- ◆ Fix both parts together using the M3x12 screw, tighten it slightly. **DON'T tighten the screw fully yet!**

## STEP 19 Aligning the XZ-axis assembly

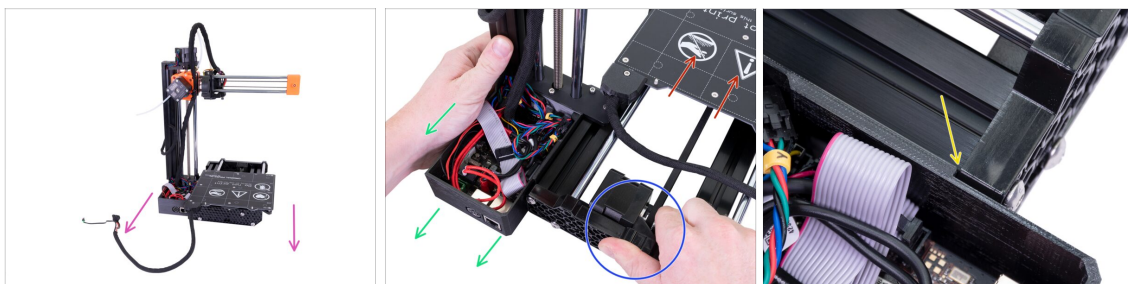

- ⚠ In this step, you will move the entire XZ-axis, avoid pushing (grinding) it against the aluminium extrusion, or you might scratch it. Leave a small gap while moving the parts.
- ◆ Rotate the back of the printer towards you.
- ◆ Push the heatbed all the way to the "front".
- ◆ Hold the Y-axis assembly.
- ◆ Move the XZ-axis assembly to the back.
- ◆ There is a notch, which indicates the correct mutual position of both parts.

## STEP 20 Final tightening

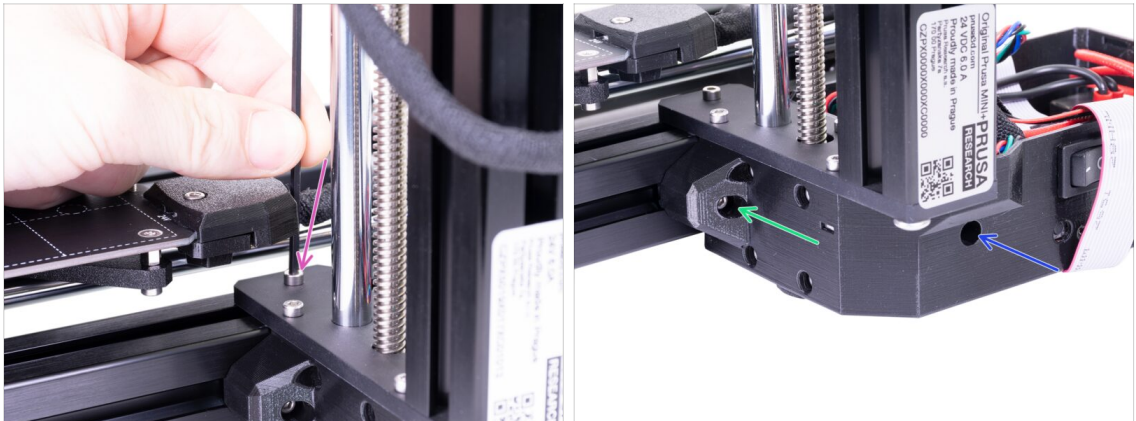

- Once the parts are aligned, **tighten all screws** in this particular order:
  - First, the M3x12 screw at the top.
  - Second, the M3x40 screw on the side.
  - Third, the M3x20 screw on the side.

## STEP 21 Haribo time!



- Arrange the bears in a similar pattern as in the picture.
- Your package might contain fewer bears.** In such a case, run immediately to the nearest candy store! **The exact dosage is absolutely critical!!!**
- Eat the upper row, leave the others for the next stages.
- I said, leave the others!

## STEP 22 LCD parts preparation

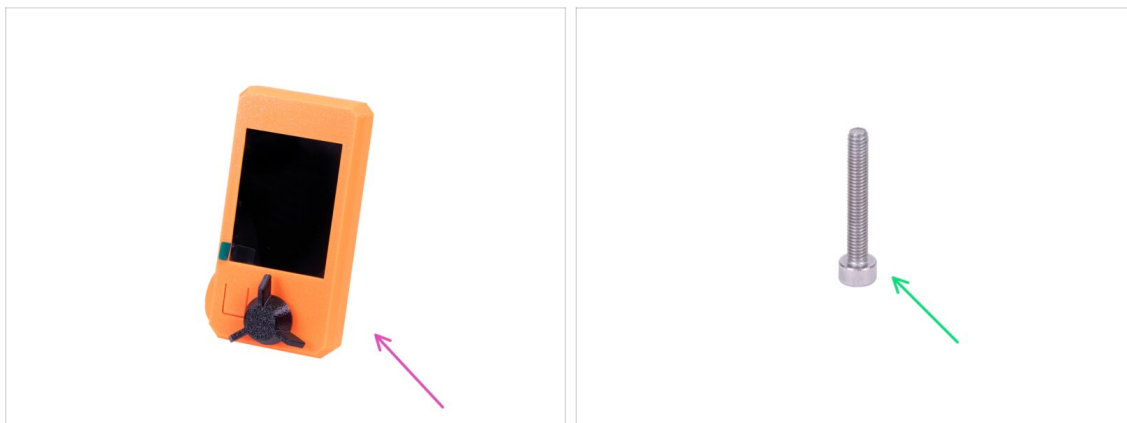

◆ For the following steps, please prepare:

◆ LCD assembly

◆ M3x20 screw (1x)

ⓘ Note there is a protective film on the screen, keep it on until the end of the assembly to prevent scratches.

## STEP 23 Mounting the LCD



◆ First, carefully tilt the printer on its side. See the picture.

◆ Place the LCD into the LCD holder. There is a notch, which fits inside the printed part on the printer.

◆ The design allows you to tilt the LCD into multiple positions. You can do it now or later.

◆ Use the M3x20 screw to connect both parts together.

ⓘ Pro tip: if you find it difficult to tighten the screw, turn over the Allen key and insert the short side of the key into the screw head. Tighten by the longer side of the key.



## STEP 24 Connecting the LCD



- ◆ Carefully remove the free end of the LCD cable from the box with the electronics and guide the cable between the Y-axis motor cable and the extrusion.
- ◆ Connect the cable to the board on the LCD. Mind the correct orientation of the connector. Use the notch as a guide
- ◆ Insert the connector in the socket on the board. Make sure it is all the way in.

## STEP 25 Guiding the LCD cable

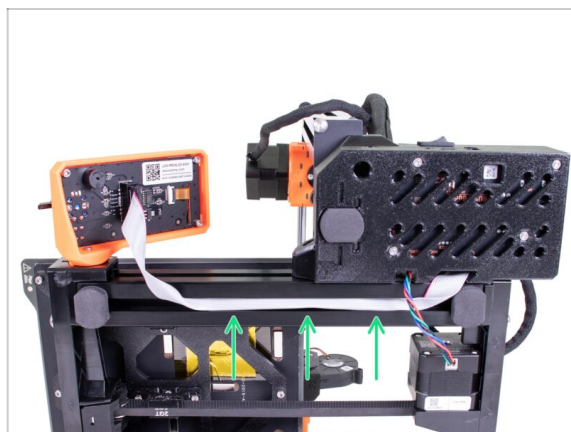

- ◆ Gently insert the cable inside the extrusion. Leave some slack outside near the LCD, so you can tilt it later on.
- ⓘ Pro tip: to insert the cable in the extrusion carefully bend it into two halves along its length.

## STEP 26 Connecting the Y-axis motor

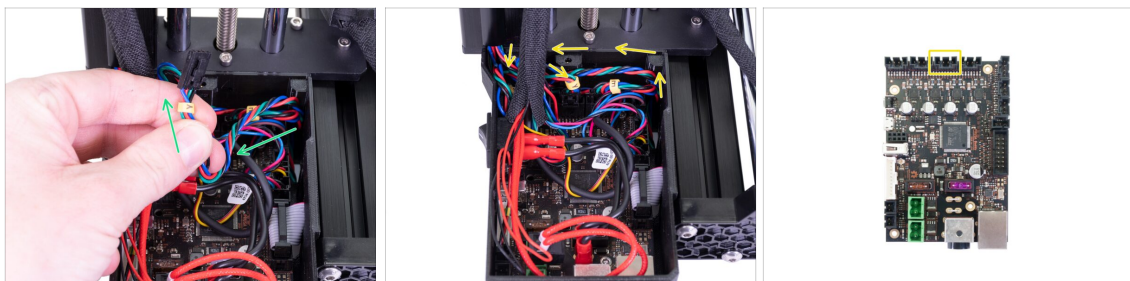

- ◆ Gently pull the Y-axis motor cable into the electronics. Do not stretch the cable. Do not use excessive pulling force. You can damage the cable.
- ◆ Connect the Y-axis motor cable into the empty slot in the top row on the Buddy board. Create a loop with the rest of the cable like in the picture.

## STEP 27 Connecting the heatbed cable

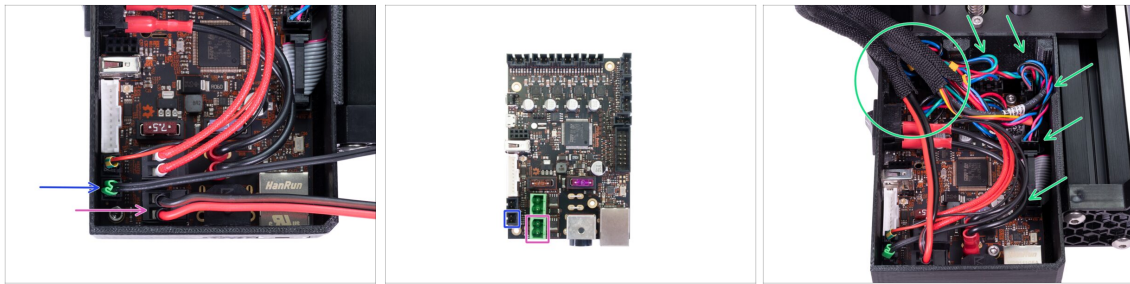

- ◆ Take the cable bundle from the heatbed and guide it into the box from the top, there is no dedicated hole. Connect the individual cables to the board:
  - ◆ Thermistor (H)
  - ◆ Heatbed heater
- ◆ Gently push the cables inside the box and position the wrap near the top left corner, where most of the cables enter the box.

## STEP 28 Filament sensor (optional)

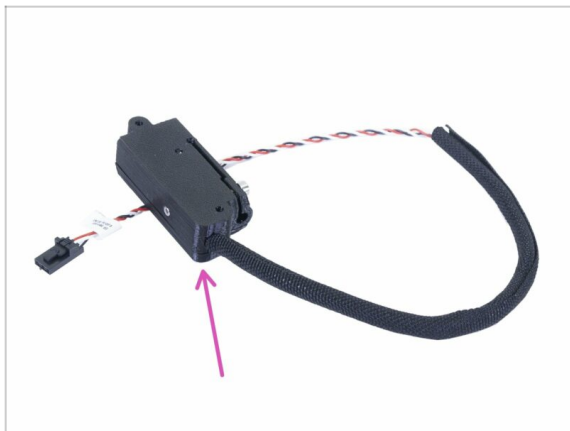

- ⓘ Some of the following steps are marked as optional. If you have a printer without the filament sensor, please skip to the step [Covering the electronics](#)
- ◆ For the following steps, please prepare:
  - ◆ Filament sensor (1x)

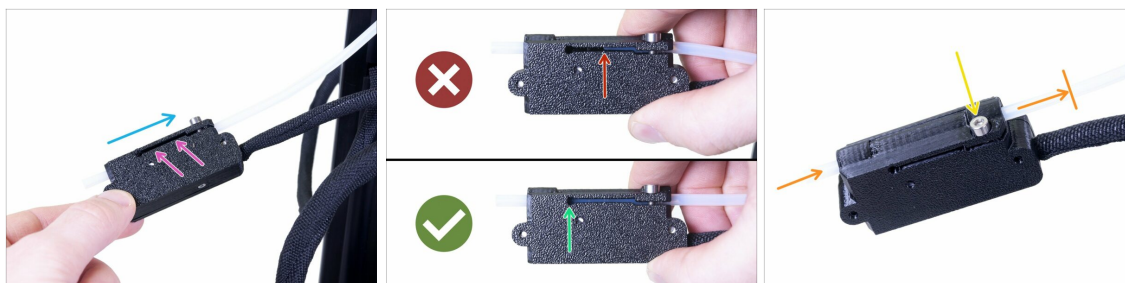
**STEP 29** Filament sensor installation (optional)

- ◆ Slide the filament sensor onto the PTFE tube. See the picture for the correct orientation of the sensor.
- ◆ Check the position of the PTFE tube through the groove:
  - ◆ **Wrong installation.** The filament sensor is not fully pushed onto the PTFE tube. The filament sensor will not work properly.
  - ◆ **Correct installation.** The filament sensor is fully pushed onto the PTFE tube.
- ◆ Now, tighten the screw gently to ensure the sensor won't slide from the PTFE tube.
- ◆ Use a piece of filament and slide it through the filament sensor to ensure there is no deformation of the tube. In case of any resistance, release the screw slightly.

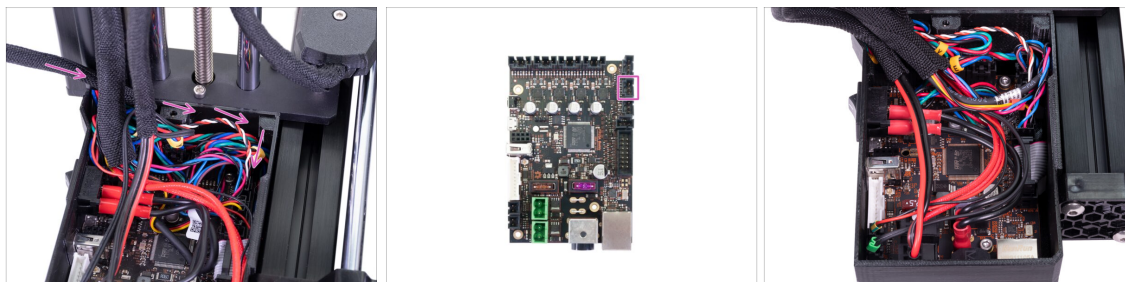
**STEP 30** Connecting the filament sensor (optional)

- ◆ Guide the filament sensor cable behind the extruder cable bundle and the heatbed cable bundle. Connect the cable into the last empty slot in the right row on the Buddy board.
- ◆ Arrange the cable according to the last picture. Keep in mind that the electronics cover must fit into place.

## STEP 31 Covering the electronics



- ◆ Before covering the electronics, make sure the square nut is correctly positioned in the printed part. **The nut must not fall out!** This can cause fatal damage to the electronics.
- ◆ Insert the cover back in, make sure it is properly seated in the slot.
- ◆ **Place the second cover on the top and arrange the cables:**
  - ◆ **Extruder bundle**, ensure the textile sleeve is partially in. Also, it must be tilted away from the printer.
  - ◆ **Heatbed bundle**, ensure the textile sleeve is partially inside the box.
  - ◆ **Filament sensor cable** (optional), ensure that the textile sleeve wrapped around the cables is partially inside the box.
- ◆ Now, tighten the second cover. Check that no cable is pinched.

## STEP 32 Haribo time!



- ◆ Phew! This concludes the connection and arrangement of all the cables.
- ◆ Take a quick break and eat another row of the bears.

## STEP 33 Spool holder parts preparation

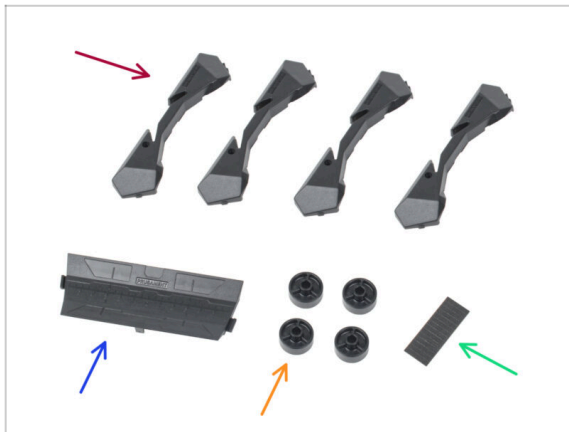

For the next steps, please prepare:

- Spool holder Base (4x)
- Spool holder Guide (1x)
- Spool holder Wheel (4x)
- Sheet of Foam Pads (1x)

## STEP 34 Base assembly (part 1)



- Take one Base part. Arrange it as seen in the picture.
- Insert two wheels into the Base.
- Cover the assembly with another Base part on top.

## STEP 35 Base assembly (part 2)



- Push both Base parts together until they fully engage one into the other.
- Verify the Base parts hold together properly.
- Repeat the same steps for the other side part of the spool holder, until you get two of these.

## STEP 36 Foam pads installation (part 1)



- Take the foam pad sheet. Bend it to separate the individual foam pad strips.
- There is a bending line inside the inner opening on the bottom of the spoolholder side part.
- Attach an individual foam pad strip onto the middle of the bending line inside the opening, as seen in the picture.

## STEP 37 Foam pads installation (part 2)

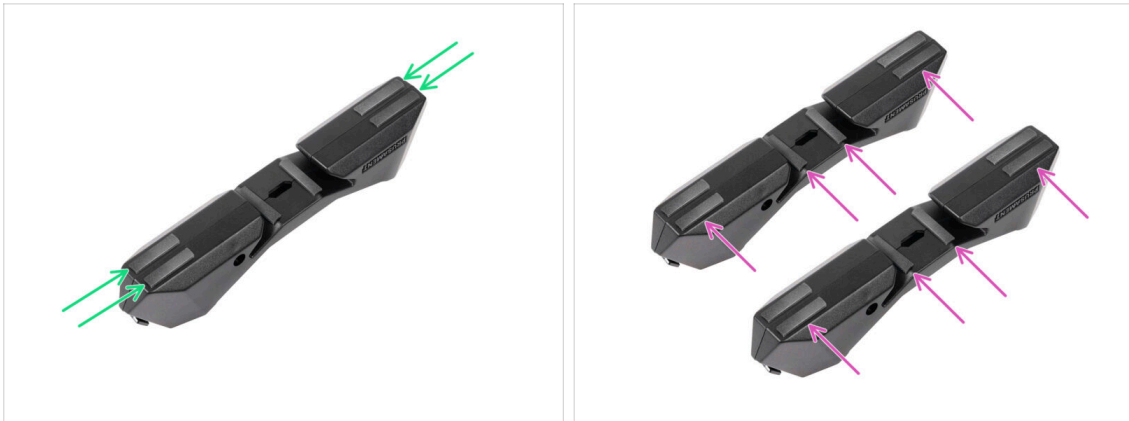

- Attach another four foam pad strips onto the marked positions on the bottom of the spool holder side part.
- Install another six foam pad strips onto the other side part of the spool holder.

## STEP 38 Adjusting the spool holder width

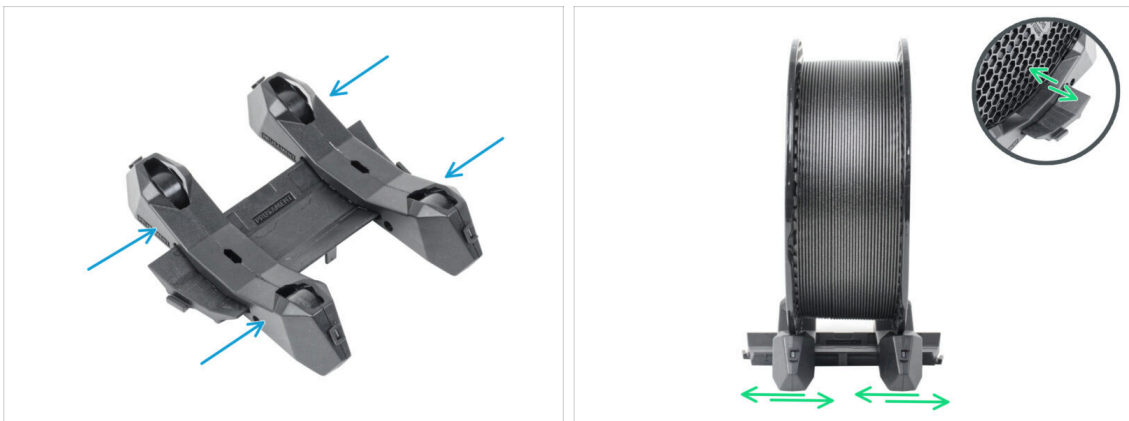

- Slide the side parts onto the Guide part.
- Place a spool of the filament you wish to use in the spool holder. Align the side parts to match the spool. *We are using a spool of Prusament as an example.*

## STEP 39 Haribo time!

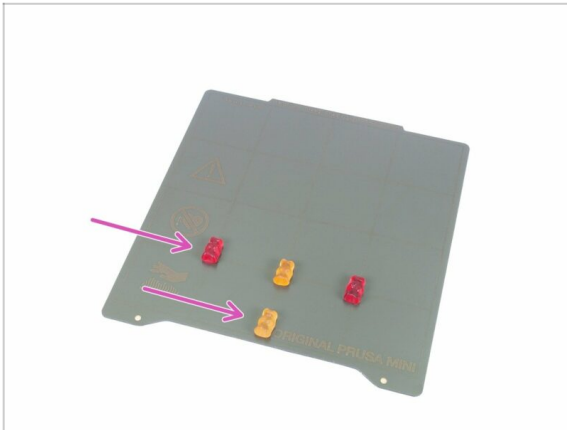

- Treat yourself for assembling the spool holder and finishing the entire assembly!
- Eat the remaining Haribo, leave no bear behind :)
- As soon as you replenish your energy, dive into the last few steps of this manual.

## STEP 40 Finalising the assembly



- **For the following step, please prepare:**
- PEI MINI sheet (1x)
- MINI power supply (1x)



## STEP 41 Connecting the PSU

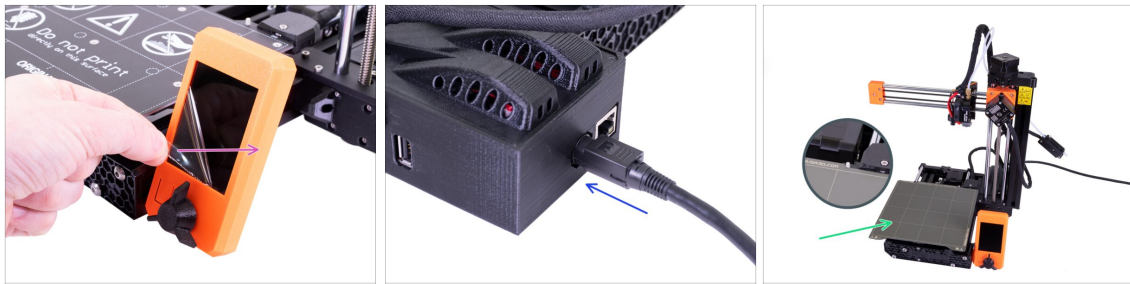

- ◆ Remove the protective film from the display.
- ◆ Connect the MINI power supply to the printer. Keep in mind the connector isn't symmetrical.
- ◆ Place the PEI MINI sheet on the heatbed. Double-check it is oriented correctly.
- ◆ **...and you're done! Good job!**
- ⓘ Prusa veterans: SuperPINDA sensor height is set from the factory, no need to adjust it now. Optimal height is 0.8-1.0 mm between the nozzle's tip and the sensor.
- ⚠ In case you have any hardware issues, after the assembly, please visit our online guide [Troubleshooting the MINI/MINI+ assembly at help.prusa3d.com](https://help.prusa3d.com).

## STEP 42 What is next?

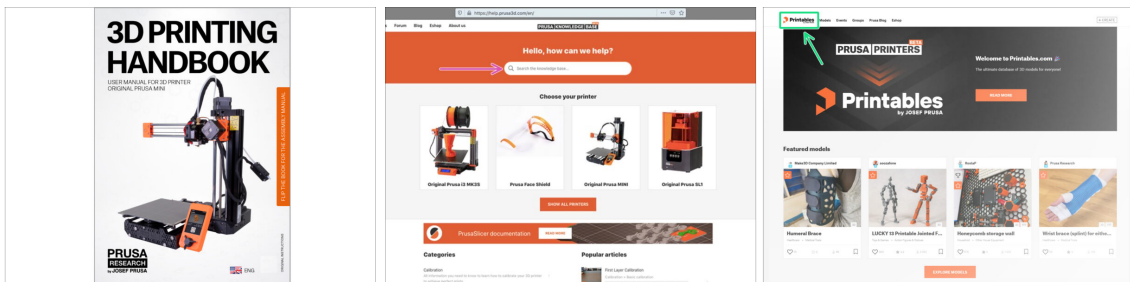

- ◆ Now, please read the **3D Printing Handbook**, which is tailor-made for your printer. The latest version is always available at [prusa3d.com/3dhandbookMINI](https://prusa3d.com/3dhandbookMINI)
- ⚠ **WARNING:** Always check for the latest firmware. You can do it online at [prusa3d.com/drivers](https://prusa3d.com/drivers) or insert the bundled USB drive in the printer. Detailed instructions are in the Handbook. *(If the USB drive includes a newer firmware than already installed, you will be prompted during the boot of the printer.)*
- ◆ Calibrate the printer according to the Handbook and use the bundled test prints to ensure your printer works correctly.
- ◆ If you encounter any problems at all, don't forget you can always check out our knowledge base at [help.prusa3d.com](https://help.prusa3d.com)
- ◆ Don't forget to join the biggest Prusa community! Download the latest models in STL or G-code tailored for your printer. Register at [Printables.com](https://Printables.com)

## Building your MINI+ (printed spool holder)



## STEP 1 Preassembled vs kit version



**⚠ Important!** There are **two versions** of the Original Prusa MINI+. Before you continue, select yours:

- **Semi-assembled version:** the printer is almost assembled and requires you to connect the major parts together. You can continue using these assembly instructions.
- **Kit version:** you have to assemble the printer using individual parts from the ground up. Please continue using the online version available at [help.prusa3d.com/MINI-kit](http://help.prusa3d.com/MINI-kit) or you can use the PDF version included on the silver USB drive.

## STEP 2 Different hardware revisions



- There are more hardware revisions of the XZ-axis, please check the following photos to select the appropriate assembly procedure:
  - **The XZ-axis has the opening on the right**, continue using this assembly guide.
  - **The XZ-axis has the opening on the left**, jump to the following guide [Building your MINI and early MINI+](#)



## STEP 5 We are here for you!

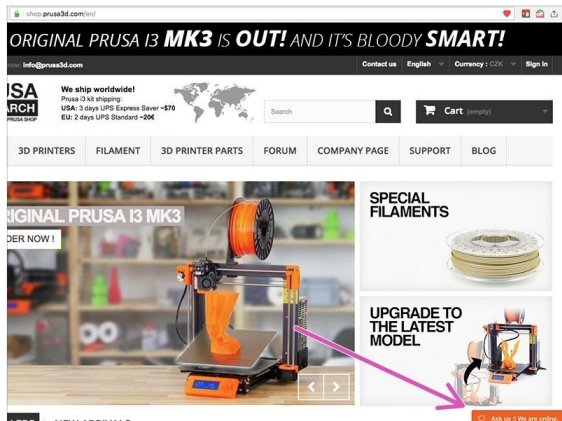
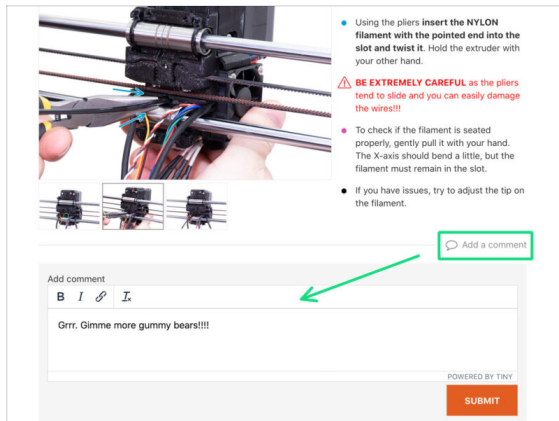

- Lost in the instructions, missing a screw or dealing with a damaged printed part? **Let us know!**
- You can contact us using the following channels:
  - In the online version, use comments under each step.
  - Use our 24/7 live chat at [shop.prusa3d.com](https://shop.prusa3d.com)
  - Write an email to [info@prusa3d.com](mailto:info@prusa3d.com)

## STEP 6 XYZ-axes parts preparation

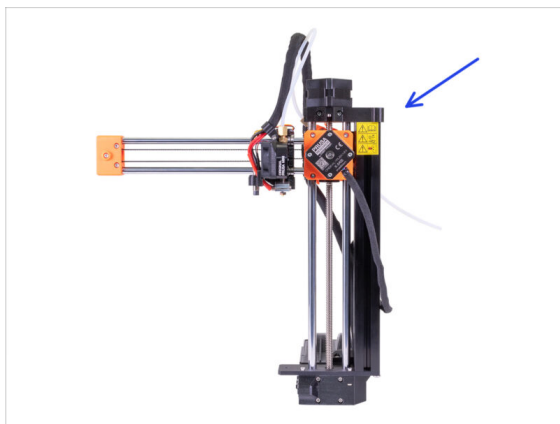

- For the following steps, please prepare:
  - XZ-axis assembly
  - M3x40 screw (1x)
  - M3x20 screw (1x)
  - M3x12 screw (1x)
- Note the second M3x20 screw in the package, will be used later on.
- The list continues in the next step...

## STEP 7 XYZ-axes parts preparation

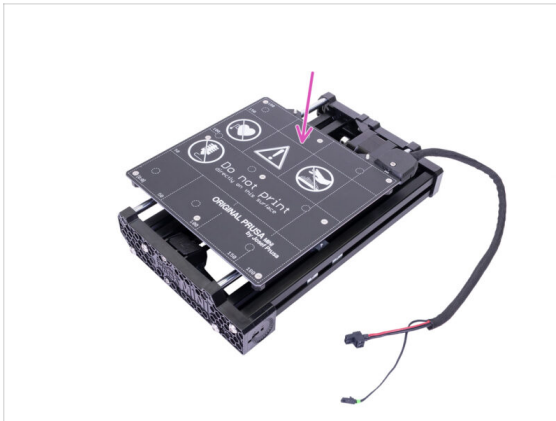

● For the following steps, please prepare:

- Y-axis assembly
- Foam block or foam pads set (1x)

## STEP 8 Foam pads - preparation

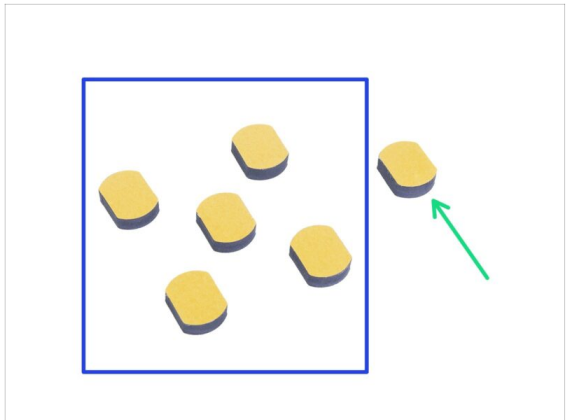
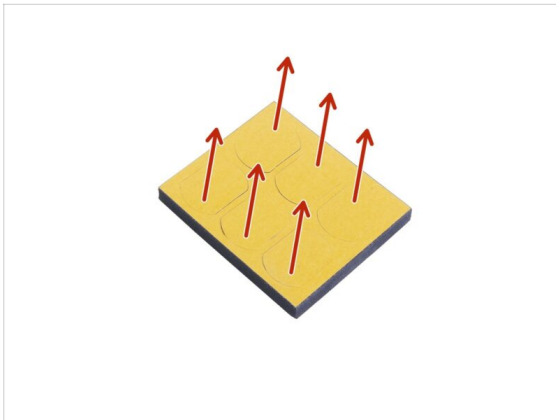

- Gently push all the pads out of the block.
- You will need five foam pads for the following steps.
- Keep the remaining sixth pad as a spare.

## STEP 9 Foam pads installation

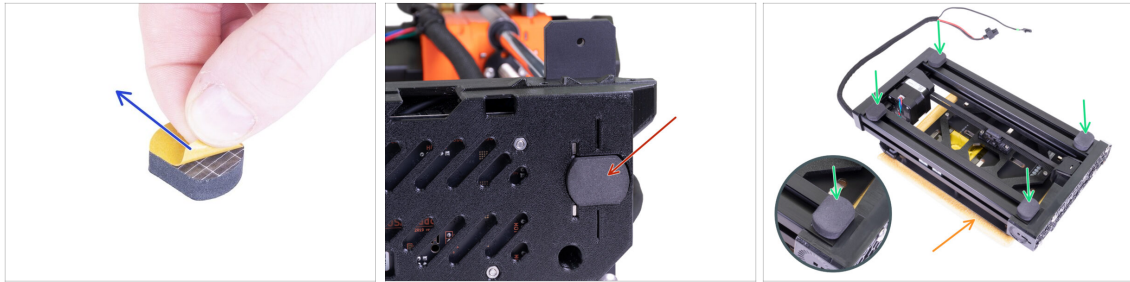

- ◆ Peel the protective film from all pads. Be careful, there is glue (adhesive) applied on the pad.
  - ◆ Lay the XZ-axis carefully on its side and glue the first foam pad into the groove on the bottom side of the electronics box.
  - ◆ Rotate the Y-axis so that the heatbed is facing down. Put a soft pad or cloth underneath it to prevent scratches.
  - ◆ Glue four foam pads onto the ends of the frame's **aluminum extrusions**, like in the picture. Mind the correct orientation.
- ⚠ **Do not glue any of these four pads on the plastic front and rear plate!**

## STEP 10 Opening the box with the electronics



- ⚠ **Make sure that the Z-axis is in the upper position. If not, using your fingers turn the leadscrew and move the Z-axis up.**
  - ◆ Release and remove the M3 screw on the box with the electronics.
  - ◆ Remove the printed cable cover.
  - ◆ Lift the electronics cover slightly. Before you remove it completely, pull it first towards the vertical aluminium extrusion to release both pins from the slots (holes on older design).
- ⓘ Keep the box opened, we need to connect multiple cables throughout this manual.

## STEP 11 Connecting the LCD cable

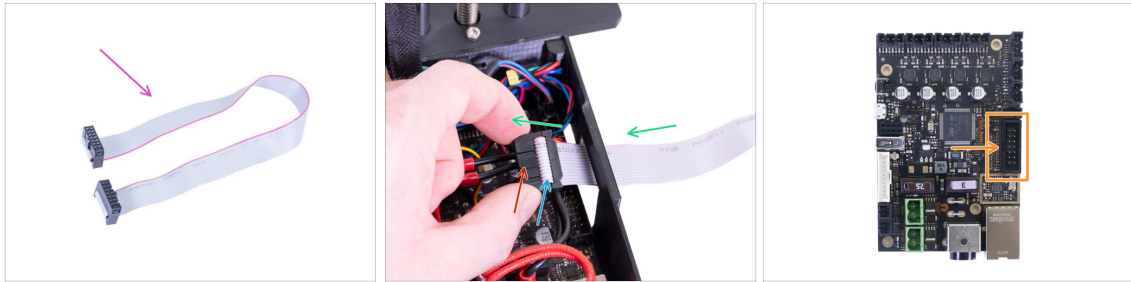

- ◆ **For this step please prepare the LCD cable (flat grey).**
- ◆ Take the LCD cable and push it through the hole in the box with the electronics.
- ◆ Make sure the "tooth" on the connector is facing up.
- ◆ Make sure the cable fold in the connector is facing up.
- ◆ Connect the LCD connector to the board. Mind the orientation of the connector, there is a notch on one side (see the arrow).



## STEP 12 Connecting the Y and XZ-axis assembly

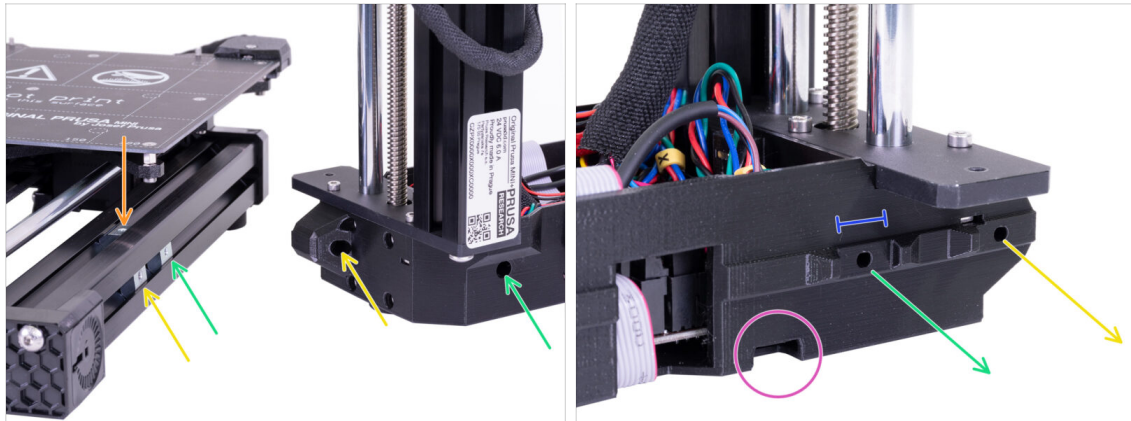

**⚠ IMPORTANT:** Read the following lines carefully. You need to align all three silver M3nE nuts in the Y-axis assembly with the correct counterpart holes in the XZ-axis assembly!

- There are a total of **three M3nE** nuts in the extrusion:
  - **The first** (the longest) on the right will be used to connect both parts together using the M3x40 screw.
  - **The second** (the second longest) will be also used to join parts, but using the M3x20 screw.
  - **The third** is located in the top part of the extrusion (not visible in the picture). The instructions on this one will be provided later on.

**⚠ Do not insert any of these screws at this time. Wait for the instructions in the following steps.**

- The second photo shows the inner side of the XZ assembly, which will be in the direct contact with aluminium extrusion and the silver M3nE nuts. Make sure the first nut fits inside the "clamp".
- Take a look at the small hole on the bottom edge. We will use this hole in the following steps to guide the cable from the Y-axis motor.

## STEP 13 Joining the parts together - preparation

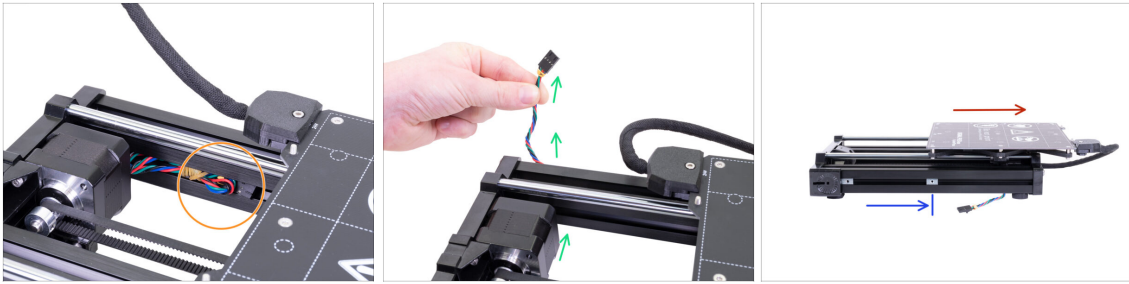

- 🟠 Locate the Y-axis motor cable placed in the extrusion and pull it out carefully.
- 🟢 Take the rubber band off from the cable, guide the cable below the extrusion and out (see the picture).
- 📄 **i** The cable on the latest units is shipped without the rubber band. However, the procedure is the same.
- 🟡 Move the heatbed all the way to the right.
- 🟡 Place the right M3nE nut approximately in the middle of the extrusion's length, but make sure it is not under the heatbed structure.

## STEP 14 Protecting the LCD cable



- ⚠️ **WARNING:** From now on proceed carefully while moving the XZ-axis. The LCD cable is facing down and might get damaged.
- ⬛ In order to protect the cable, please follow the instructions below. Also, don't try any other orientation, because it will complicate the assembly.
- 🟡 Carefully lay the XZ-axis on its side (see the picture) and start wrapping the LCD cable around the box. Don't stretch the cable.
- 🟡 Now, tilt the axis back to get better access inside the electronics box and gently insert the cable in. Make a loop under the power button cables. Note, that this is only a temporary solution.

## STEP 15 Joining the parts together - phase 1

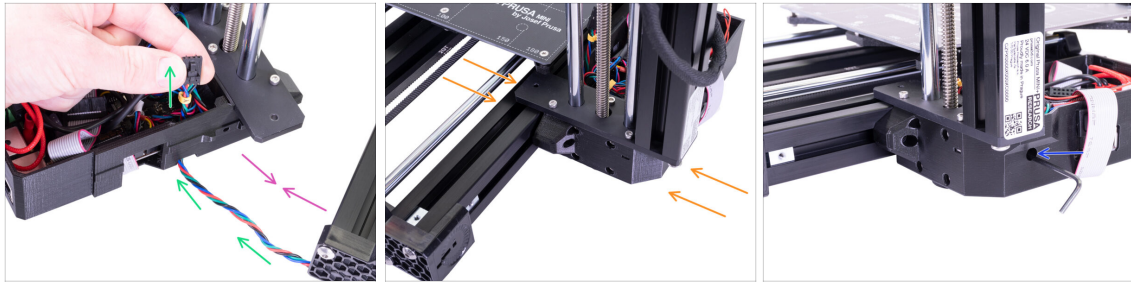

- ◆ Move the XZ-axis closer to the Y-axis so that the Y-axis motor cable reaches the electronics.
- ◆ Guide the Y-axis motor cable through the hole in the electronics box. Do not connect the cable to the electronics yet, we'll connect it later.
- ◆ Push both parts together and try fitting the "clamp" (XZ assembly) directly on the M3nE nut, which you have moved to the centre of the extrusion.
- ⚠ **WARNING: Be careful not to pinch the Y-axis motor cable between both parts!**
- ◆ Use the M3x40 screw to connect both parts. In case you can't reach the thread of the nut, wiggle with the screw a bit inside the plastic base of the printer. **DON'T tighten the screw fully yet!**

## STEP 16 Joining the parts together - phase 2

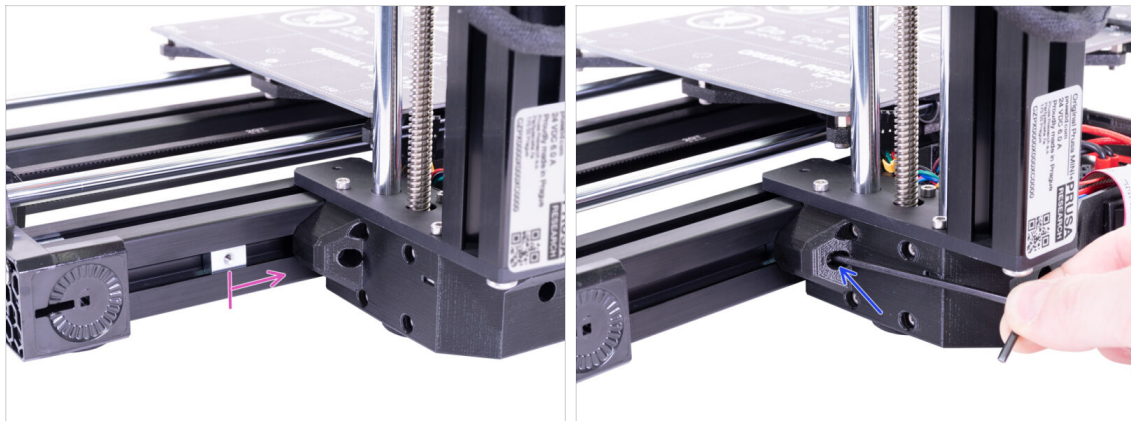

- ◆ Take the second M3nE nut from the left and move it all the way to the right, use the Allen key and gently push it in. There is a notch inside, which will align it properly for the second screw.
- ◆ Use the M3x20 screw and again tighten it just slightly, but ensure you have reached the nut. **DON'T tighten the screw fully yet!**

## STEP 17 Joining the parts together - phase 3

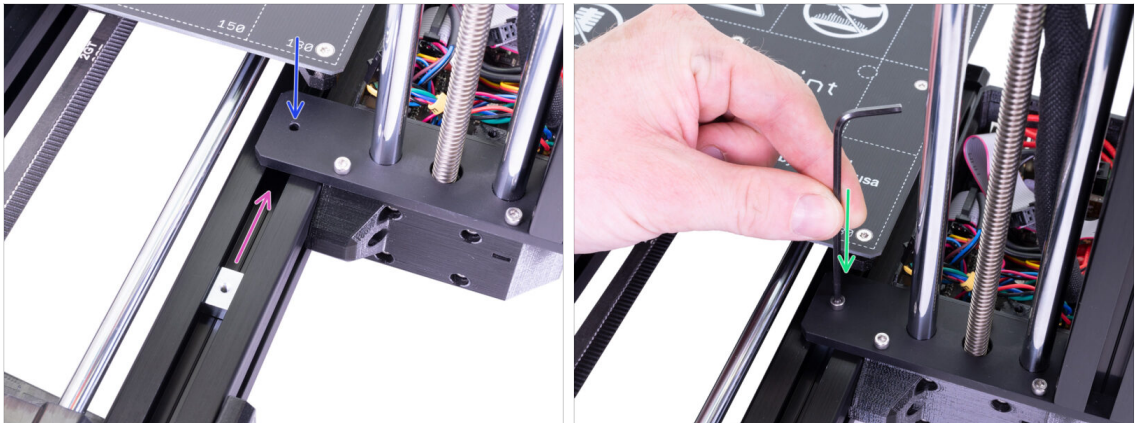

- ◆ Now, take the M3nE nut in the upper part of the extrusion and slide it under the steel plate.
- ◆ Make sure the hole in the nut matches the hole in the plate. Use the Allen key to align it.
- ◆ Fix both parts together using the M3x12 screw, tighten it slightly. **DON'T tighten the screw fully yet!**

## STEP 18 Aligning the XZ-axis assembly

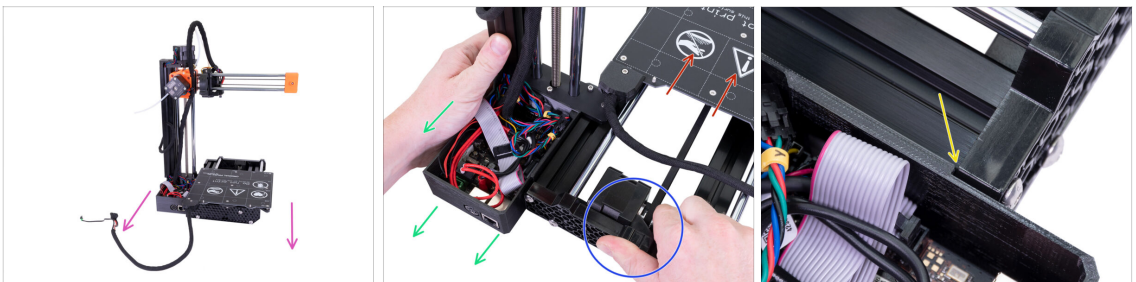

- ⚠ In this step, you will move the entire XZ-axis, avoid pushing (grinding) it against the aluminium extrusion, or you might scratch it. Leave a small gap while moving the parts.
- ◆ Rotate the back of the printer towards you.
- ◆ Push the heatbed all the way to the "front".
- ◆ Hold the Y-axis assembly.
- ◆ Move the XZ-axis assembly to the back.
- ◆ There is a notch, which indicates the correct mutual position of both parts.

## STEP 19 Final tightening

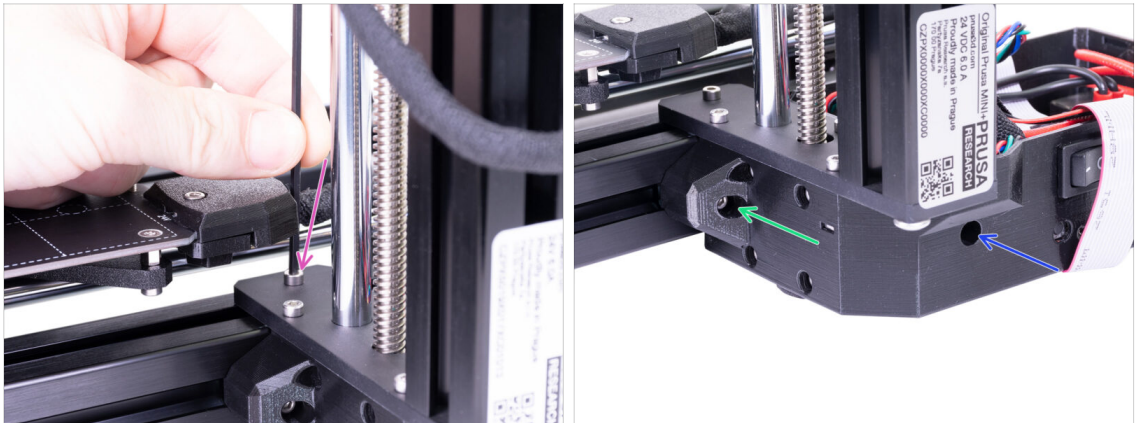

- Once the parts are aligned, **tighten all screws** in this particular order:
  - First, the M3x12 screw at the top.
  - Second, the M3x40 screw on the side.
  - Third, the M3x20 screw on the side.

## STEP 20 Haribo time!



- Arrange the bears in a similar pattern as in the picture.
- Your package might contain fewer bears.** In such a case, run immediately to the nearest candy store! **The exact dosage is absolutely critical!!!**
- Eat the upper row, leave the others for the next stages.
- I said, leave the others!

## STEP 21 LCD parts preparation

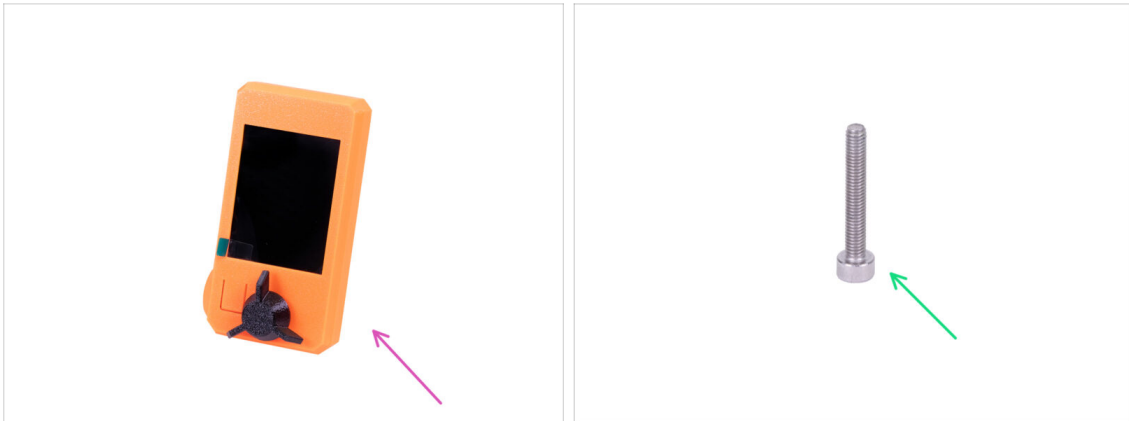

◆ For the following steps, please prepare:

◆ LCD assembly

◆ M3x20 screw (1x)

ⓘ Note there is a protective film on the screen, keep it on until the end of the assembly to prevent scratches.

## STEP 22 Mounting the LCD



◆ First, carefully tilt the printer on its side. See the picture.

◆ Place the LCD into the LCD holder. There is a notch, which fits inside the printed part on the printer.

◆ The design allows you to tilt the LCD into multiple positions. You can do it now or later.

◆ Use the M3x20 screw to connect both parts together.

ⓘ Pro tip: if you find it difficult to tighten the screw, turn over the Allen key and insert the short side of the key into the screw head. Tighten by the longer side of the key.

## STEP 23 Connecting the LCD



- Carefully remove the free end of the LCD cable from the box with the electronics and guide the cable between the Y-axis motor cable and the extrusion.
- Connect the cable to the board on the LCD. Mind the correct orientation of the connector. Use the notch as a guide
- Insert the connector in the socket on the board. Make sure it is all the way in.

## STEP 24 Guiding the LCD cable

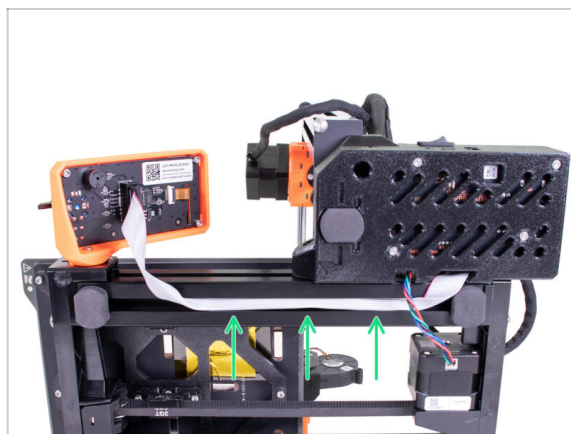

- Gently insert the cable inside the extrusion. Leave some slack outside near the LCD, so you can tilt it later on.
- ⓘ Pro tip: to insert the cable in the extrusion carefully bend it into two halves along its length.

## STEP 25 Connecting the Y-axis motor



- Gently pull the Y-axis motor cable into the electronics. Do not stretch the cable. Do not use excessive pulling force. You can damage the cable.
- Connect the Y-axis motor cable into the empty slot in the top row on the Buddy board. Create a loop with the rest of the cable like in the picture.

## STEP 26 Connecting the heatbed cable

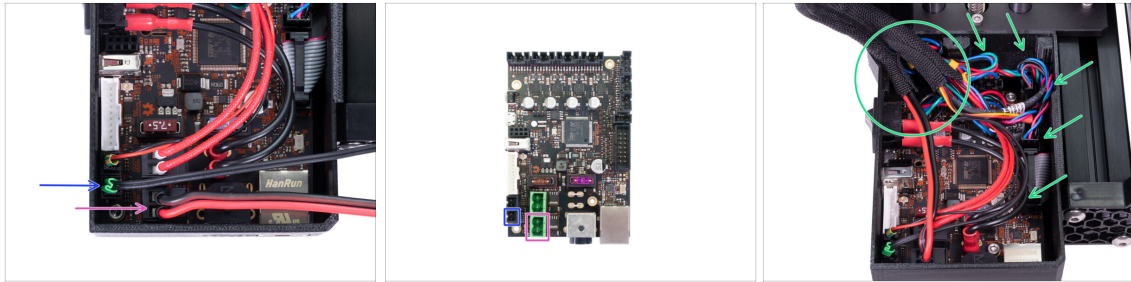

- ◆ Take the cable bundle from the heatbed and guide it into the box from the top, there is no dedicated hole. Connect the individual cables to the board:
  - ◆ Thermistor (H)
  - ◆ Heatbed heater
- ◆ Gently push the cables inside the box and position the wrap near the top left corner, where most of the cables enter the box.

## STEP 27 Filament sensor (optional)

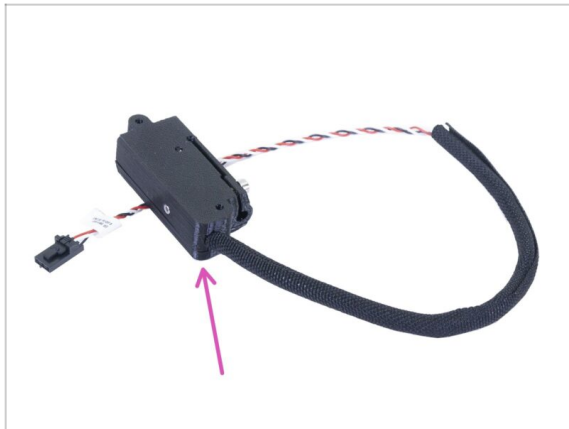

- ⓘ Some of the following steps are marked as optional. If you have a printer without the filament sensor, please skip to the step [Covering the electronics](#)
- ◆ For the following steps, please prepare:
  - ◆ Filament sensor (1x)



## STEP 28 Filament sensor installation (optional)

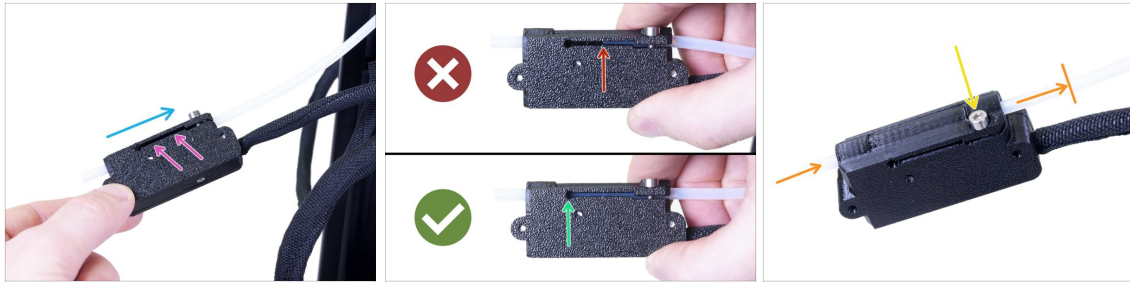

- ◆ Slide the filament sensor onto the PTFE tube. See the picture for the correct orientation of the sensor.
- ◆ Check the position of the PTFE tube through the groove:
  - ◆ **Wrong installation.** The filament sensor is not fully pushed onto the PTFE tube. The filament sensor will not work properly.
  - ◆ **Correct installation.** The filament sensor is fully pushed onto the PTFE tube.
- ◆ Now, tighten the screw gently to ensure the sensor won't slide from the PTFE tube.
- ◆ Use a piece of filament and slide it through the filament sensor to ensure there is no deformation of the tube. In case of any resistance, release the screw slightly.

## STEP 29 Connecting the filament sensor (optional)

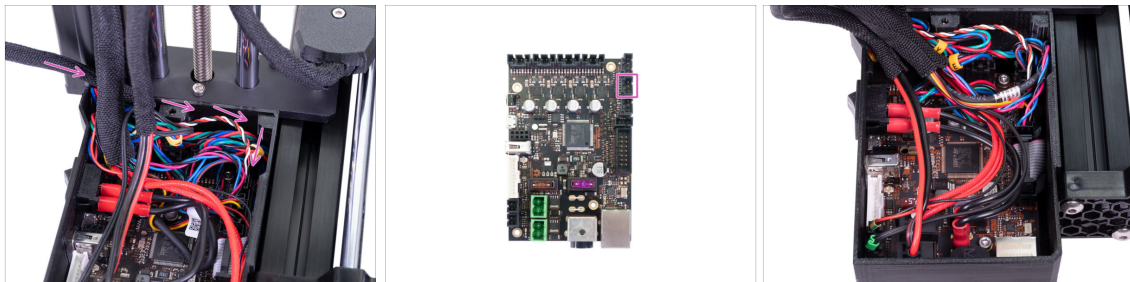

- ◆ Guide the filament sensor cable behind the extruder cable bundle and the heated bed cable bundle. Connect the cable into the last empty slot in the right row on the Buddy board.
- ◆ Arrange the cable according to the last picture. Keep in mind that the electronics cover must fit into place.

## STEP 30 Covering the electronics

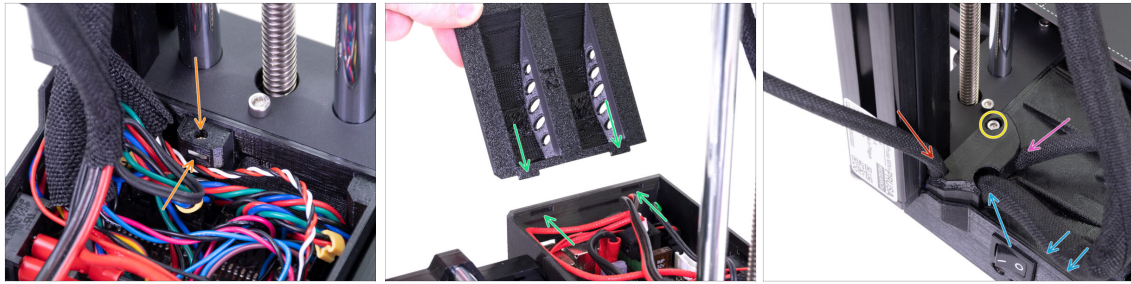

- Before covering the electronics, make sure the square nut is correctly positioned in the printed part. **The nut must not fall out!** This can cause fatal damage to the electronics.
- Insert the cover back in, make sure it is properly seated in the slot.
- **Place the second cover on the top and arrange the cables:**
  - **Extruder bundle**, ensure the textile sleeve is partially in. Also, it must be tilted away from the printer.
  - **Heatbed bundle**, ensure the textile sleeve is partially inside the box.
  - **Filament sensor cable** (optional), ensure that the textile sleeve wrapped around the cables is partially inside the box.
- Now, tighten the second cover. Check that no cable is pinched.

## STEP 31 Haribo time!



- Phew! This concludes the connection and arrangement of all the cables.
- Take a quick break and eat another row of the bears.

## STEP 32 Spool holder parts preparation

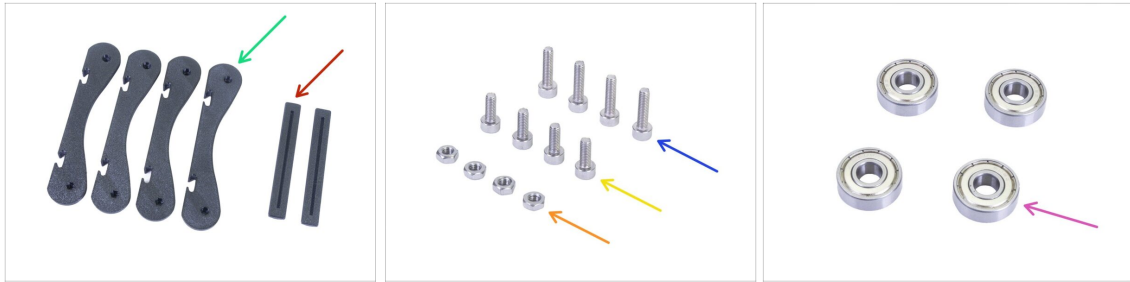

◆ **For the next steps, please prepare:**

◆ MINI base spool holder (4x)

◆ MINI rail spool holder (2x)

◆ M3x12 screw (4x)

◆ M3x8 screw (4x)

◆ M3n nut (4x)

◆ Bearing 608Z (4x)

ⓘ The list continues in the next step...

## STEP 33 Spool holder parts preparation



◆ **For the following steps, please prepare:**

◆ Anti-vibration pad (4x)

## STEP 34 Assembling the spool holder base(s)



- Take the two BASE parts and insert the M3n nuts into the holes in both of them - see the picture. If you can't push them in, insert a screw from the opposite side to pull them in.
- Flip one of the BASE parts and insert two bearings in it.
- Put the second BASE part on top of the bearings.
- Insert the M3x12 screw from the top and tighten it. Flip the base assembly over and do the same.
- Make sure both bearings can rotate freely. If not, release the screw(s) slightly.
- Repeat this step** for the second base assembly.

## STEP 35 Adding the spool holder rails



- Slide both rails in the first base assembly, use the grooves. Align the rail with the edge of the base.
- Secure the first base with two M3x8 screws. Use a reasonable force during the tightening.
- Slide the second base onto the rails. The exact position is not important at this point - we will adjust it in the next step.

## STEP 36 Adjusting the spool holder width



- Place a spool of the filament you wish to use in the spool holder. Align the second base to match the size of the spool. *We are using a spool of Prusament as an example.*
- Once the holder is aligned, remove the spool, insert two M3x8 screws and tighten them to prevent the parts from moving.

## STEP 37 Attaching anti-slip pads

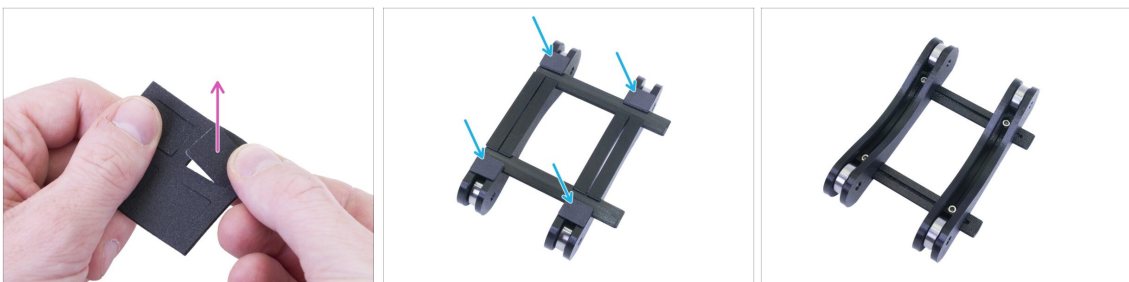

- Grab the bundled anti-slip board and break out four pads.
- Peel off the protective film and attach the pads from the bottom side of the spool holder.
- i** Tip: avoid attaching the pads near or on the rails, it might make future width adjustments harder.

## STEP 38 Haribo time!

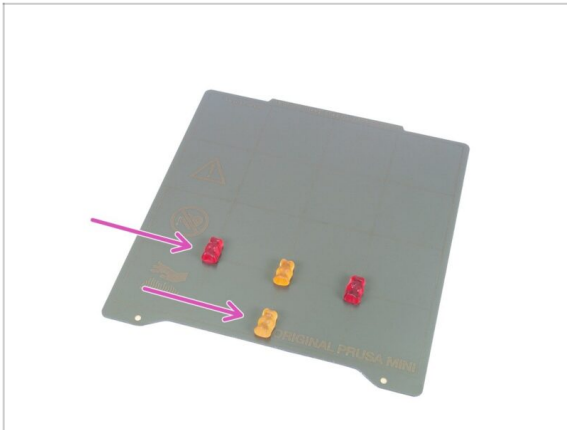

- Treat yourself for assembling the spool holder and finishing the entire assembly!
- Eat the remaining Haribo, leave no bear behind :)
- As soon as you replenish your energy, dive into the last few steps of this manual.

## STEP 39 Finalising the assembly

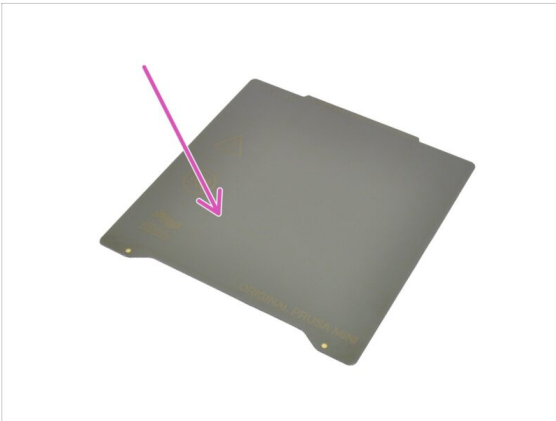

- **For the following step, please prepare:**
- PEI MINI sheet (1x)
- MINI power supply (1x)

## STEP 40 Connecting the PSU

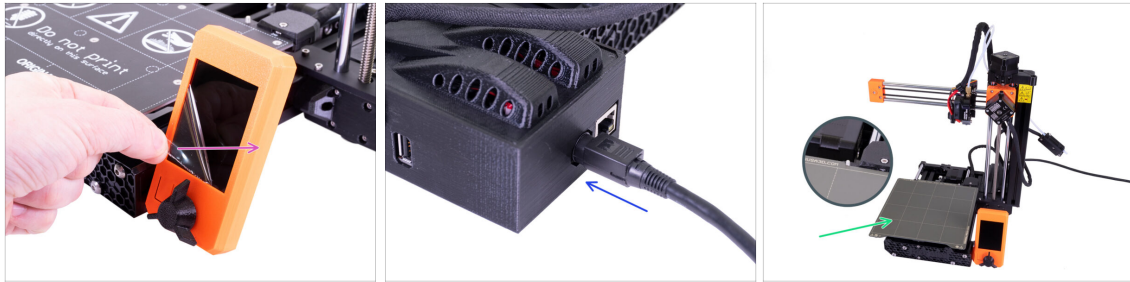

- ◆ Remove the protective film from the display.
- ◆ Connect the MINI power supply to the printer. Keep in mind the connector isn't symmetrical.
- ◆ Place the PEI MINI sheet on the heatbed. Double-check it is oriented correctly.
- ◆ ...and you're done! Good job!
- ⓘ Prusa veterans: SuperPINDA sensor height is set from the factory, no need to adjust it now. Optimal height is 0.8-1.0 mm between the nozzle's tip and the sensor.
- ⚠ In case you have any hardware issues, after the assembly, please visit our online guide [Troubleshooting the MINI/MINI+ assembly at help.prusa3d.com](https://help.prusa3d.com).

## STEP 41 What is next?

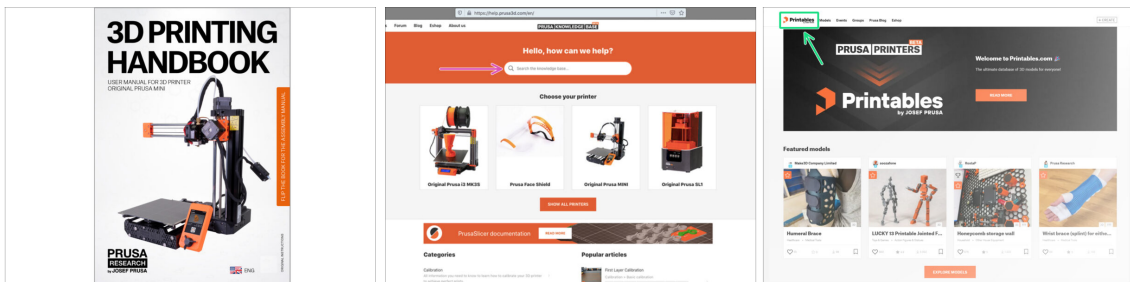

- ◆ Now, please read the **3D Printing Handbook**, which is tailor-made for your printer. The latest version is always available at [prusa3d.com/3dhandbookMINI](https://prusa3d.com/3dhandbookMINI)
- ⚠ **WARNING:** Always check for the latest firmware. You can do it online at [prusa3d.com/drivers](https://prusa3d.com/drivers) or insert the bundled USB drive in the printer. Detailed instructions are in the Handbook. (If the USB drive includes a newer firmware than already installed, you will be prompted during the boot of the printer.)
- ◆ Calibrate the printer according to the Handbook and use the bundled test prints to ensure your printer works correctly.
- ◆ If you encounter any problems at all, don't forget you can always check out our knowledge base at [help.prusa3d.com](https://help.prusa3d.com)
- ◆ Don't forget to join the biggest Prusa community! Download the latest models in STL or G-code tailored for your printer. Register at [Printables.com](https://Printables.com)

# Manual changelog MINI+ semi-assembly





## STEP 1 Version history



- ◆ **Versions of the MINI+ semi-assembly manual:**
- ◆ 11/2020 - Initial version 1.05
- ◆ 1/2021 - Updated to version 1.06
- ◆ 3/2021 - Updated to version 1.07
- ◆ 1/2022 - Updated to version 1.08
- ◆ 4/2022 - Updated to version 1.09
- ◆ 1/2023 - Updated to version 1.10
- ◆ 5/2023 - Updated to version 1.11

---

## STEP 2 Changes to the manual (1)



- ◆ 11/2020 - Handbook update
- ◆ Manual version 1.05

---

### STEP 3 Changes to the manual (2)



- 01/2021 - Handbook update
- i** Manual version 1.06

---

### STEP 4 Changes to the manual (3)



- 03/2021 - Handbook update
- i** Manual version 1.07

---

## STEP 5 Changes to the manual (4)



- 01/2022 - Handbook update
  - Fixed chapter numbering.
  - Updated material table.
  - Updated steel sheet maintenance.
- i** Manual version 1.08

---

## STEP 6 Changes to the manual (5)



- 04/2022 - Handbook and manual update
  - Updated rebranding of Prusaprinters to Printables.
- i** Manual version 1.09

## STEP 7 Changes to the manual (6)



- 01/2023 - Handbook and manual update
  - Added information about the ESP Wi-Fi module.
- i** Manual version 1.10

## STEP 8 Changes to the manual (7)



- 05/2023 - Spool holder assembly
  - Added instructions for assembling the new version of the Spool holder (injection molded).
- i** Manual version 1.11

















